



SERVOCOMANDO THERMAL DRIVE

Art. 9567

Servocomando elettrotermico. Disponibile con alimentazione 230V o 24V con o senza contatto ausiliario.

Thermal drive. Available with 230V or 24V power supply with or without auxiliary contacts.

I servocomandi elettrotermici Tiemme vengono prevalentemente utilizzati negli impianti di riscaldamento a pannelli radianti per l'attuazione degli elementi termostatzabili sui collettori di distribuzione oppure negli impianti di riscaldamento tradizionali per l'attuazione delle valvole termostatzabili previa sostituzione della ghiera di fissaggio (vedere pagina 4).

Il loro funzionamento e' del tipo a pistone e si basa sulla spinta data dall'aumento di volume di una cera sintetica posta all'interno di una cartuccia. La valvola è del tipo "normalmente chiusa" con comando on-off.

The Tiemme thermal drive are mainly used on the floor heating systems for the control of the thermostatic elements placed on distribution manifolds or on the traditional heating systems for the control of thermostatic valves by replacing of the adaptor (see page 4).

The valves are based on a piston movement due to the volume increasing of a synthetic wax placed into a capsule. The valves are "normally closed" type with on-off switch.



Per la gamma completa vedere il catalogo / For complete range see catalogue

Caratteristiche Tecniche Technical Features

Tensione d'esercizio:	24-230 V AC, 50/60 Hz
Operating Voltage:	24-230V AC, 50/60 Hz
Potenza d'esercizio:	1 W
Operating Power:	1 W
Corrente d'inserzione:	max. 550 mA per max. 100 ms
Max. Inrush Current:	max.550 mA for max. 100 ms
Corsa:	4 mm
Stroke:	4 mm
Finecorsa	
Corrente di commutazione:	24-230V AC: 5 A (1 A)
End-Switch	
Switching Current:	24-230 V AC: 5 A (1 A)
Classe di protezione:	II
Protection Class:	II
Grado di protezione:	IP 54
Degrees of IP protection:	IP 54
Temperatura ambiente:	0°C ... 60°C
Room Temperature:	0°C ... 60°C
Temperatura di stoccaggio:	-25°C ... 60°C
Storage Temperature:	-25°C ... 60°C

Impiego vietato nel caso di cavo danneggiato
Do not use if the cable is defective

NOTA IMPORTANTE

Il servocomando 9567 è dotato, per facilitare l'installazione sul collettore, della funzione "PRIMA APERTURA". Quando viene montato la prima volta sul collettore, si comporta come un servocomando normalmente aperto, permettendo il flusso all'interno dell'uscita del collettore. Se alimentato per un tempo superiore ai 6 minuti, il servocomando si inizializza, portandosi nella sua configurazione originale di servocomando normalmente chiuso.

IMPORTANT NOTE

In order to make it easier to install on the collector, the servo control 9567 is fitted with the "FIRST OPEN" function. When it is mounted for the first time on the solar collector, it behaves like a normally open servo control, allowing flow inside the collector outlet. If fed for more than 6 minutes, the servo control initializes itself, returning to its original configuration of normally closed servo control.

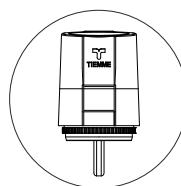

IP54

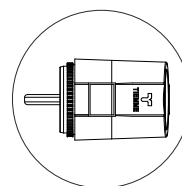

IP54

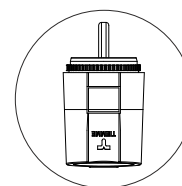

IP54

Dimensioni Dimensions

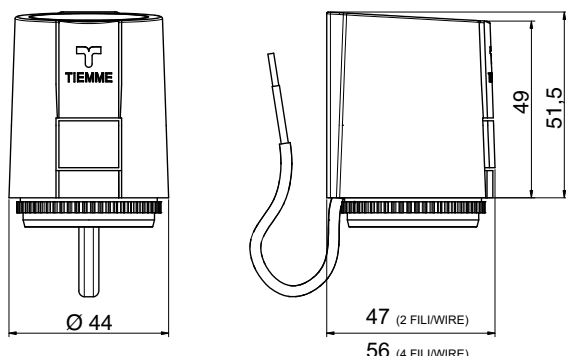

STANDARD Art. 450 0669

Fornita con il servocomando
Supplied with thermal drive

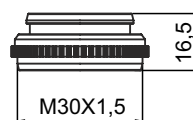

per installazione su collettori
per sistemi radianti
for installation on manifolds
for radiant systems

Art. 450 0411

Acquistabile a parte
Affordable as a spare

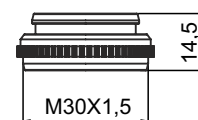

per installazione su valvole
radiatore termostatzabili
for installation on
thermostatic radiator valves



Schemi di collegamento Electrical wiring

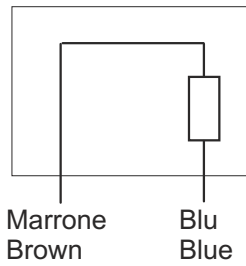
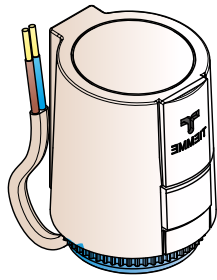

Marrone
Brown

Blu
Blue

4500026 (9567T024) (24V~ 2 fili)
4500026 (9567T024) (24V~ 2 wire)
4500012 (9567T220) (230V~ 2 fili)
4500012 (9567T220) (230V~ 2 wire)

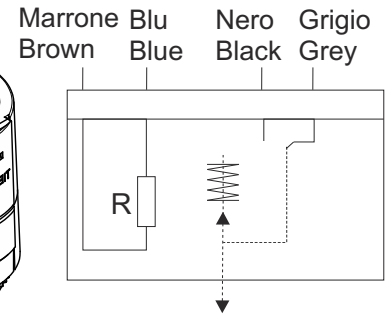
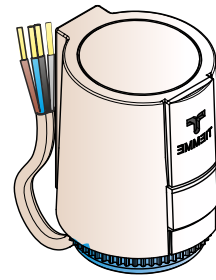

Marrone Blu Nero Grigio
Brown Blue Black Grey

4500045 (9567T024F4) (24V~ 4 fili)
4500045 (9567T024F4) (24V~ 4 wire)
4500006 (9567T220F4) (230V~ 4 fili)
4500006 (9567T220F4) (230V~ 4 wire)

ATTENZIONE
Per il corretto funzionamento del comando, l'impianto elettrico deve essere dimensionato in base alla corrente di spunto.
Qualora si debbano eseguire regolazioni di più zone con servocomandi in parallelo allo stesso termostato, occorre valutare l'eventualità di inserire un relè di potenza intermedio per evitare sovraccarichi elettrici.

WARNING
For the correct functioning of the actuator, the electrical circuit should be sized on the basis of the starting current.
If it is necessary to control multiple zones with actuators in parallel using the same thermostat, the possibility of including an intermediate power relay to prevent electrical overload should be considered

Per poter comandare l'apertura e la chiusura dei vari circuiti, le teste elettrotermiche devono essere collegate elettricamente ad un termostato. Di seguito due esempi di collegamento:

- 1) termostato e testa elettrotermica SENZA contatto ausiliario
- 2) termostato e testa elettrotermica CON contatto ausiliario

To control the opening and closure of the various circuits, the thermal drive must be electrically connected to a thermostat. The following wiring diagrams refer to:

- 1) thermostat and electrothermic head WITHOUT auxiliary contact
- 2) thermostat and electrothermic head WITH auxiliary contact

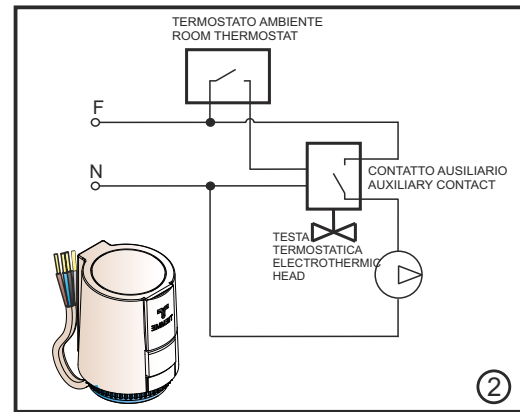
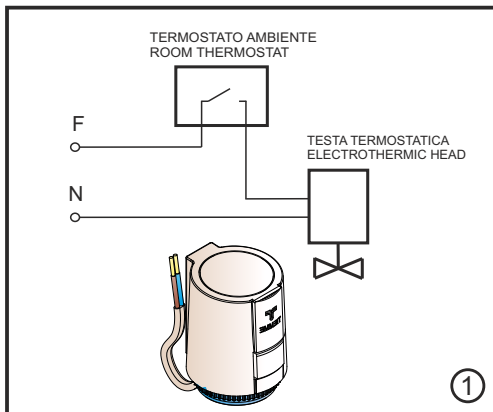

Istruzioni per montaggio su collettori Mounting instructions on manifolds

Il funzionamento corretto del prodotto è garantito solo in abbinamento a collettori e valvole per radiatori Temme
Correct product functioning is guaranteed only when used together with Tiemme radiator manifolds and valves

Montaggio Mounting

1
**TAGLIARE
CUT**

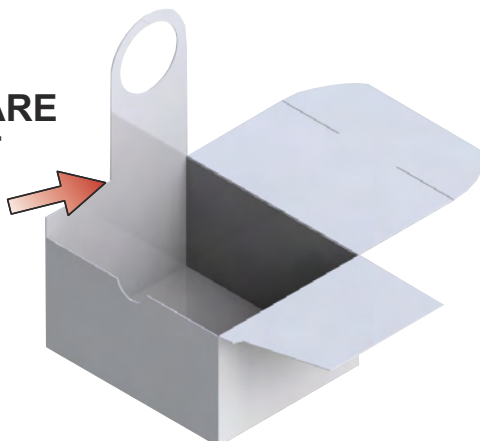

2



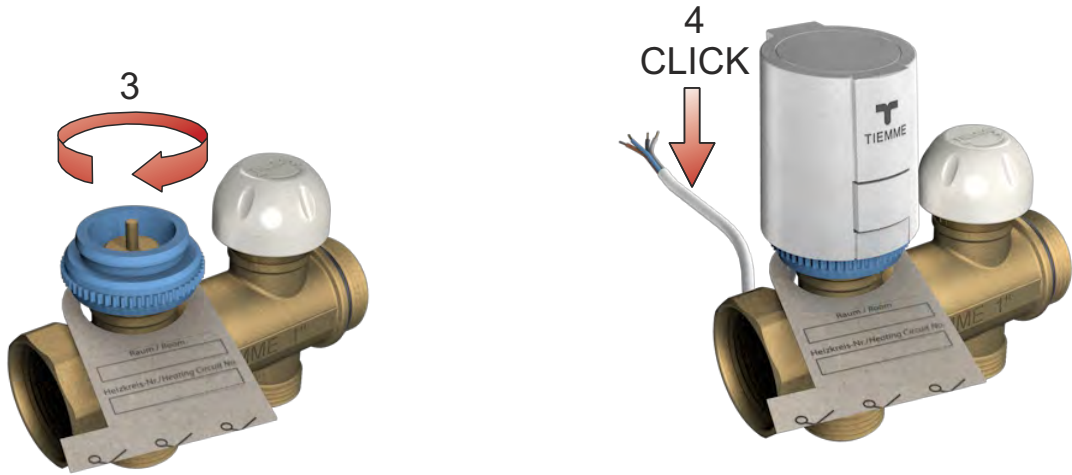

Smontaggio Dismounting

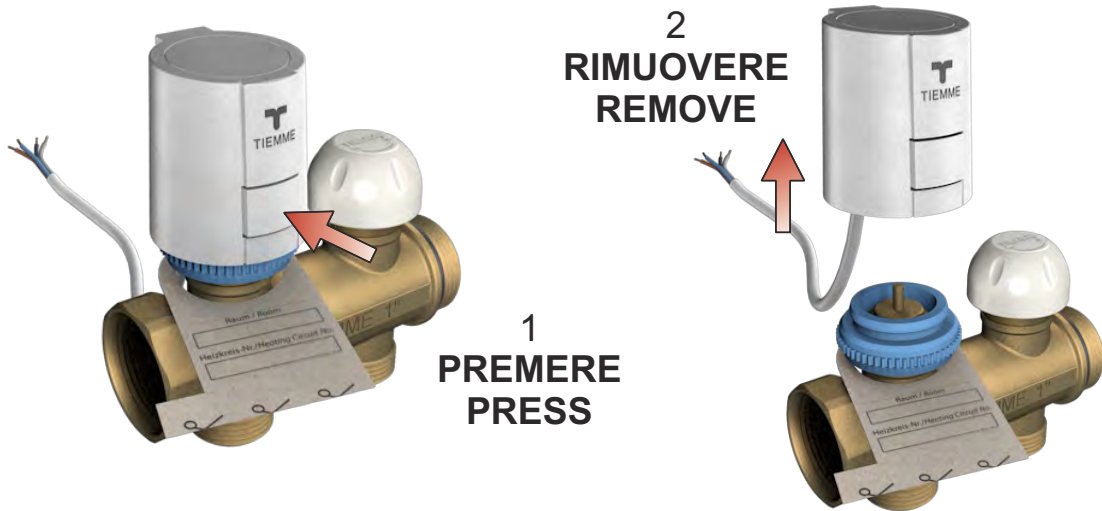

Istruzioni per montaggio su valvole termostattabili per radiatori Mounting instructions on thermostatic radiators valves

Il funzionamento corretto del prodotto è garantito solo in abbinamento a collettori e valvole per radiatori Temme
Correct product functioning is guaranteed only when used together with Tiemme radiator manifolds and valves

Montaggio Mounting

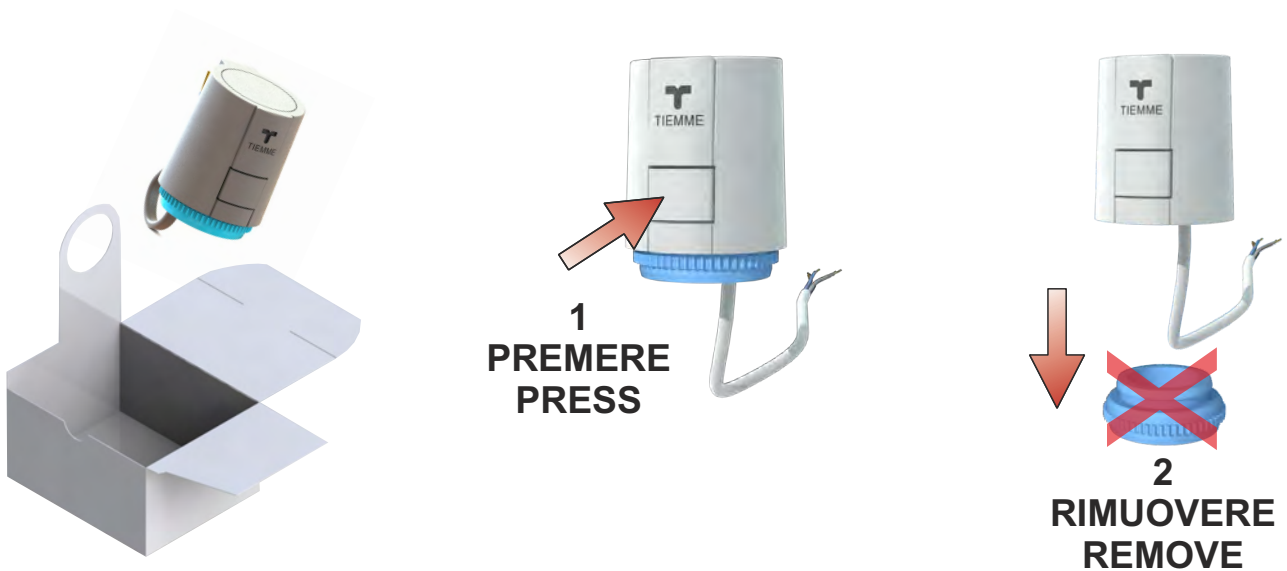



3
SOSTITUIRE
CON 4500411
REPLACE WITH
4500411

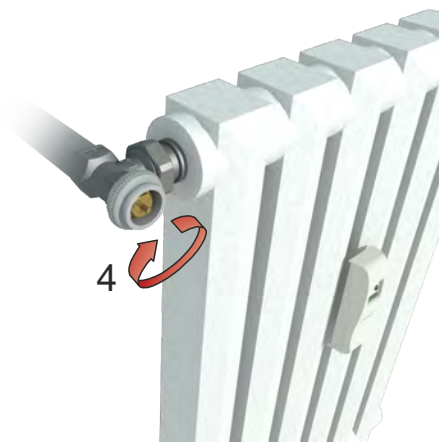

Smontaggio
Dismounting

1
PREMERE
PRESS

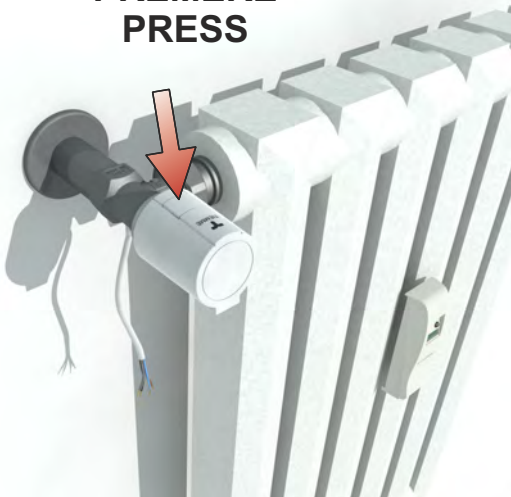

2
RIMUOVERE
REMOVE

