

3500

“YACHT”

CHECK VALVE WITH POLYAMIDE SHUTTER



DESCRIPTION

Once installed in the hydraulic circuit, the YACHT valve allows the circulation of fluid in the direction established by the check device only and prevents the fluid from flowing in the opposite direction.

The spring shutter rises, opening the valve at a pressure of about 25 mbar.

It adapts to any type of heating/cooling and plumbing system, with application in residential, commercial, industrial and agricultural sectors.

When used as an anti-pollution valve, it prevents the aqueduct network from being polluted by the accidental return of contaminated fluid from the downstream system (UTILITIES), due to pressure variations in the distribution network.

The check valve, installed between the public network and the user network in water distribution systems, prevents contact between the waters contained in the two networks, by closing automatically if backflow occurs.

Check valve Art. 3500 can be used to protect the water network against the risk of contamination from water **up to category 2** (for more information refer to the "INFORMATION FROM TIEMME" section of this technical data sheet).

ADVANTAGES / STRENGTHS

- Guarantees perfect hydraulic sealing against even slight pressure variations in the circuit.
- Can be installed in horizontal and vertical positions.

PRODUCTION RANGE

| Art. | Code | Connections | DN | PN (bar) |
|------|----------|-------------------|-----|----------|
| 3500 | 350 0003 | G 1/2" (ISO 228) | 15 | 12 |
| | 350 0004 | G 3/4" (ISO 228) | 20 | 12 |
| | 350 0001 | G 1" (ISO 228) | 25 | 12 |
| | 350 0006 | G 1"1/4 (ISO 228) | 32 | 10 |
| | 350 0008 | G 1"1/2 (ISO 228) | 40 | 10 |
| | 350 0007 | G 2" (ISO 228) | 50 | 10 |
| | 350 0022 | G 2"1/2 (ISO 228) | 65 | 8 |
| | 350 0018 | G 3" (ISO 228) | 80 | 8 |
| | 350 0034 | G 4" (ISO 228) | 100 | 8 |

CONSTRUCTION SPECIFICATIONS

- (1) Body: CW617N Brass
- (2) Shutter: PA
- (3) Seal press: PA
- (4) Seal: NBR
- (5) Spring: AISI 302 stainless steel
- Threads: ISO 228

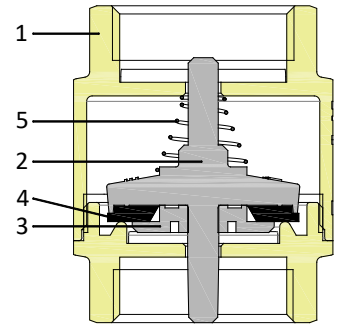

CARATTERISTICHE TECNICHE

- Maximum working temperature: + 100 °C
- Minimum working temperature: -20 °C (provided the fluid remains in the liquid phase)
- Maximum working pressure: 12 bar (1/2" ÷ 1") - 10 bar (1"1/4 ÷ 2") - 8 bar (2"1/2 ÷ 4")
- Minimum opening pressure: 25 mbar
- Fluid compatibility: Drinking water, water and glycol solutions (maximum glycol percentage 30%), oils, petroleum products, non corrosive fluids *

* To check compatibility with fluids or other substances not listed, contact the Tiemme Technical Department.

DIMENSIONAL SPECIFICATIONS

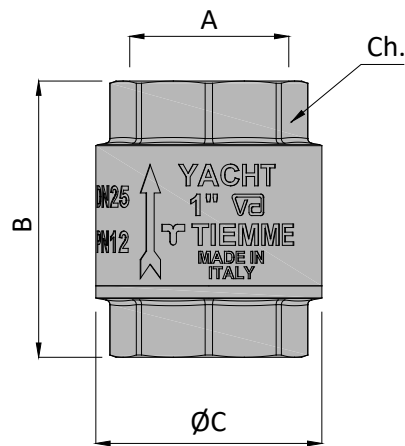

| Art. | Code | DN | A | B | ØC | Ch. |
|------|----------|-----|-----------|-------|-------|-----|
| 3500 | 350 0003 | 15 | G 1/2" F | 45.5 | 34.5 | 26 |
| | 350 0004 | 20 | G 3/4" F | 51.5 | 41.5 | 32 |
| | 350 0001 | 25 | G 1" F | 58 | 47.5 | 39 |
| | 350 0006 | 32 | G 1"1/4 F | 64.5 | 60 | 47 |
| | 350 0008 | 40 | G 1"1/2 F | 72.5 | 70.5 | 55 |
| | 350 0007 | 50 | G 2" F | 80 | 86.5 | 66 |
| | 350 0022 | 65 | G 2"1/2 F | 93.5 | 101.5 | 83 |
| | 350 0018 | 80 | G 3" F | 103.5 | 124 | 96 |
| | 350 0034 | 100 | G 4" F | 116.5 | 155 | 123 |

Dimensions in mm

OPERATION

In normal circuit operating conditions (**UPSTREAM pressure > DOWNSTREAM pressure**), the flow passing through the valve opens the spring shutter, to guarantee the passage of water.

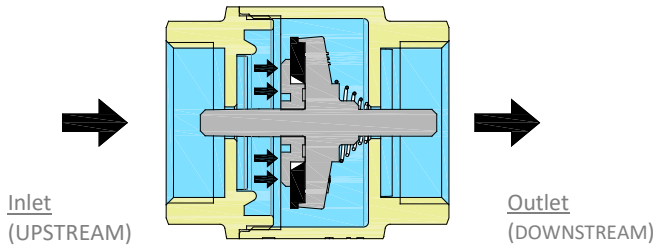

CHECK DEVICE **OPEN**
(UPSTREAM pressure > DOWNSTREAM pressure)

Otherwise, when these conditions are no longer present (**UPSTREAM pressure < DOWNSTREAM pressure**), the pressure generated by the fluid contained in the downstream pipe section closes the spring shutter, preventing the return of the fluid.

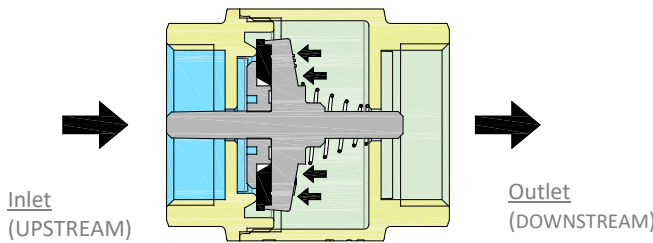

CHECK DEVICE **CLOSED**
(UPSTREAM pressure < DOWNSTREAM pressure)

HYDRAULIC SPECIFICATIONS

Diagram 1: Flow rate/pressure drop.

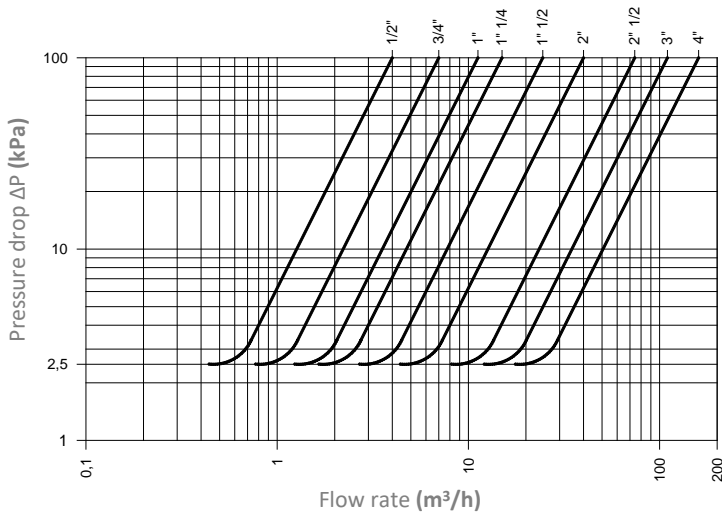

| Measurement | Kv (m³/h) |
|-------------|-----------|
| G 1/2" | 4,44 |
| G 3/4" | 7,35 |
| G 1" | 11,66 |
| G 1 1/4" | 16,89 |
| G 1 1/2" | 24,58 |
| G 2" | 39,78 |
| G 2 1/2" | 75,90 |
| G 3" | 109,85 |
| G 4" | 158,90 |

Diagram 2: Pressure/temperature.

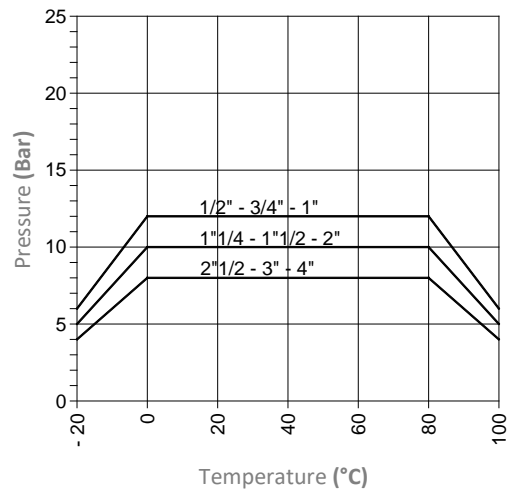

INSTALLATION

- Provide a ball shut-off valve upstream of the check valve.

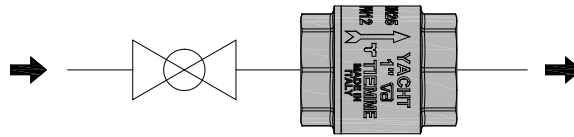

- The valve can be installed either in a **horizontal** or **vertical** position.
- Remove any impurities in the pipe before installing the valve. It is good practice to provide a filter upstream of the check valve.
- Respect the flow direction indicated by the arrow printed on the valve body.



- In the event of application with the function of an anti-pollution device, install the valve downstream of the water metre.
- Make sure that the anti-pollution check valve selected is suitable for the degree of danger of the water in the supply to be protected. In the case of degree of danger classification in Categories 3, 4 and 5 provide the appropriate devices (e.g. backflow preventers).

TIEMME RACCORDERIE S.p.A. will not be held responsible for any failures and/or accidents resulting from failure to comply with these instructions and/or from improper use of the system. The information given does not exempt the user from scrupulously following the regulations and good technical standards that are currently in force.

ACCESSORIES



Art. 3510

AISI 304 stainless steel filter with a filtration level of 1000 µm. Combined with the YACHT check valve, in the event of application as a foot valve, it guarantees valid protection for circulation pumps.

See the product catalogue for further details.

INFORMATION FROM TIEMME

European standard EN 1717

The correct use of the check valve, when used as an anti-pollution device on the water mains network, is regulated by European regulations regarding the prevention of backflow pollution.

The reference standard is EN 1717 "Protection against pollution of potable water installations and general requirements of devices to prevent pollution by backflow".

In this standard, the water contained in the systems is classified according to the degree of danger to human health:

- | | |
|-------------|--|
| category 1: | Water to be used for human consumption coming directly from a potable water distribution system. |
| category 2: | Fluid presenting no human health hazard, as in 1, which has undergone a change in temperature, taste, odour or appearance. |
| category 3: | Fluid representing some human health hazard due to the presence of harmful substances. |
| category 4: | Fluid representing a human health hazard due to the presence of one or more "toxic" or "very toxic" substances or one or more radioactive, mutagenic or carcinogenic substances. |
| category 5: | Fluid presenting a human health hazard due to the presence of microbiological or viral elements. |

Based on this classification, suitable anti-backflow devices must be installed in the water distribution circuits of systems.

The check valves **Art. 3500 can be used to protect the water supply network against the risk of contamination from water up to category 2.**

Beyond this category, in the event of a higher degree of danger, it is advisable to provide other protection devices such as backflow preventers.

ITEM SPECIFICATIONS

Art. 3500

Check valve with polyamide shutter made of: CW617N brass body, PA shutter, PA seal presses, NBR seal, AISI 302 stainless steel spring, ISO 228 threads.

Maximum working temperature: + 100 °C. Minimum working temperature: - 20 °C (provided that the fluid remains in the liquid phase).

Maximum working pressure: 12 bar (1/2" ÷ 1"), 10 bar (1"1/4 ÷ 2"), 8 bar (2"1/2 ÷ 4"). Minimum opening pressure 25 mbar.

Fluid compatibility: Drinking water, water and glycol solutions (maximum percentage of glycol 30%), oils, petroleum products, non-corrosive fluids.

Production range: Connection fittings G 1/2" ÷ G 4".

CERTIFICATIONS

